

Coupe VERTICALE

Dormant Périphérique

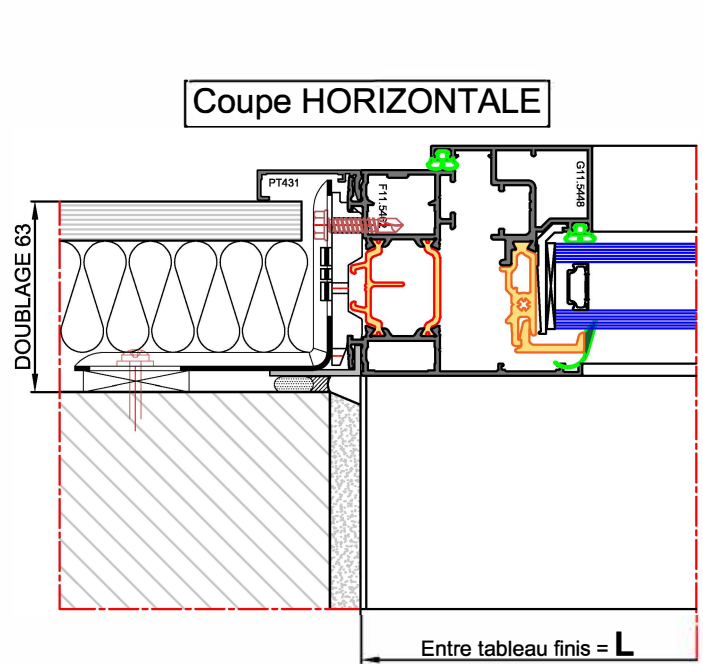
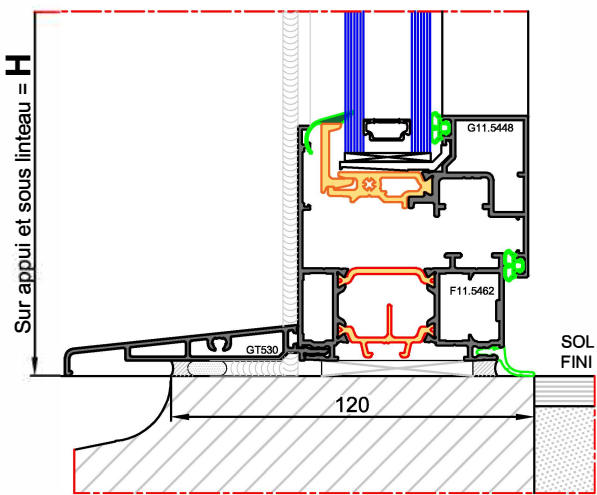

Coupe HORIZONTALE

Battement CENTRAL OF

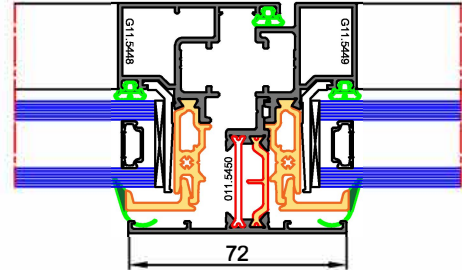

Battement CENTRAL PF serrure

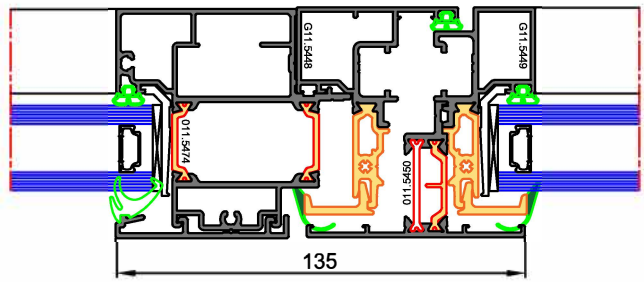

Seuil PMR

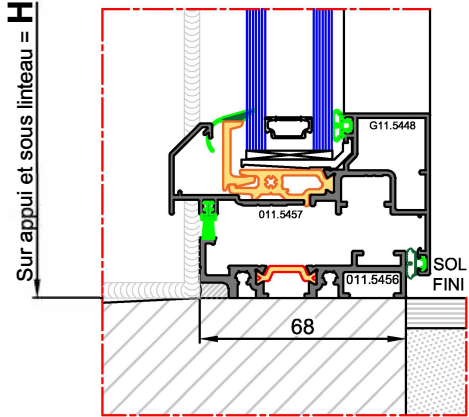

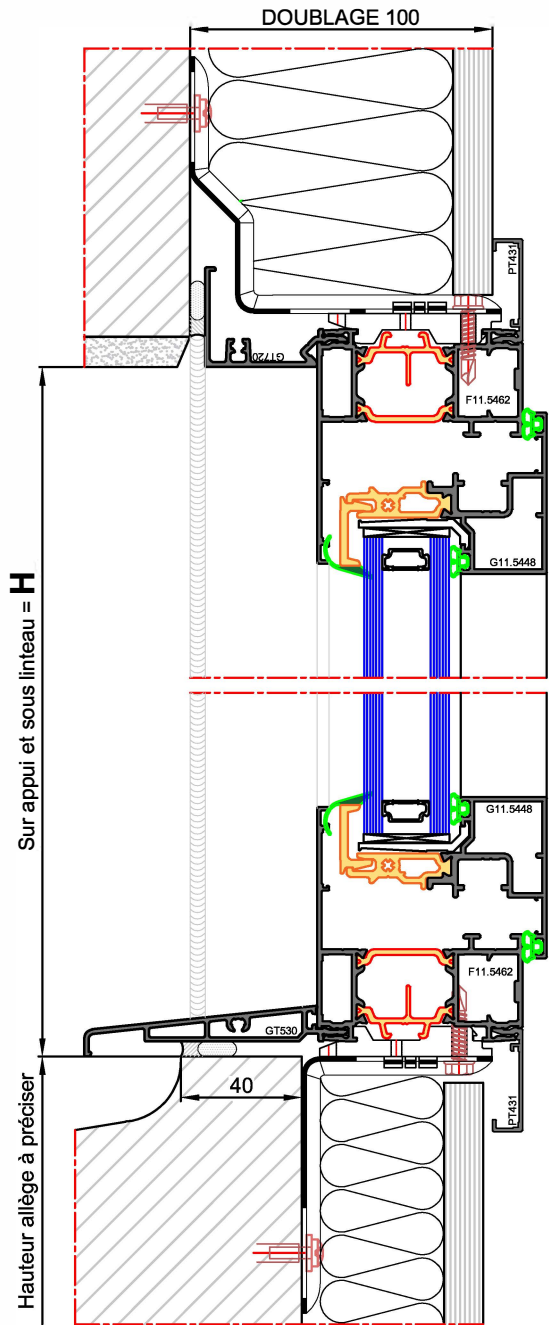

Coupe VERTICALE

Dormant Périphérique

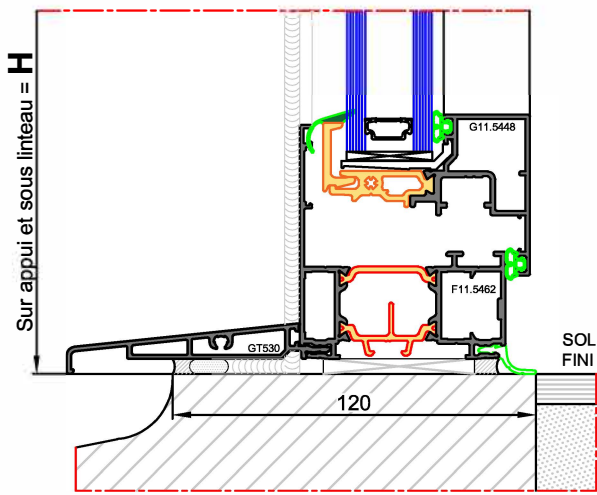

Hauteur allège à préciser

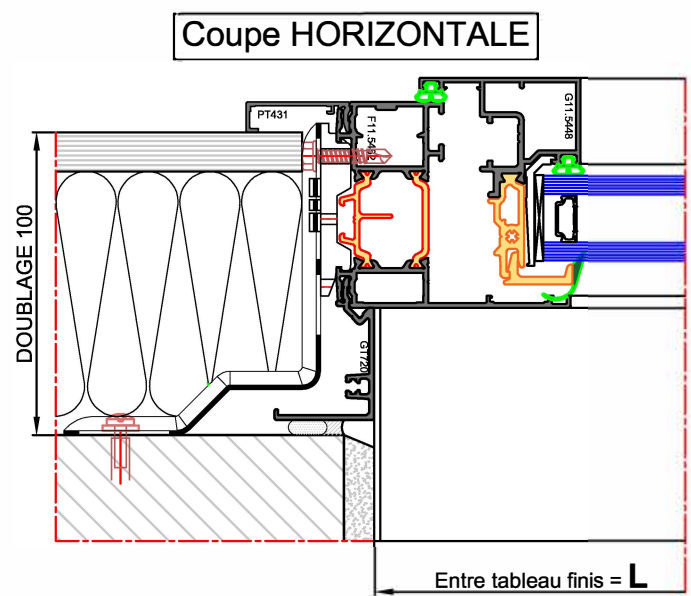

Coupe HORIZONTALE

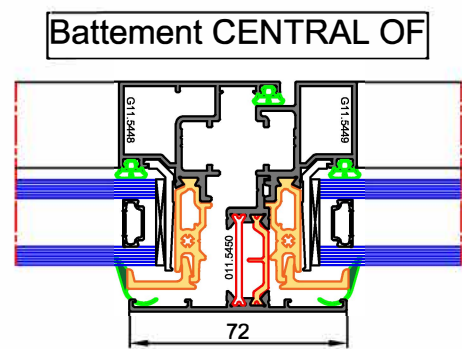

Battement CENTRAL OF

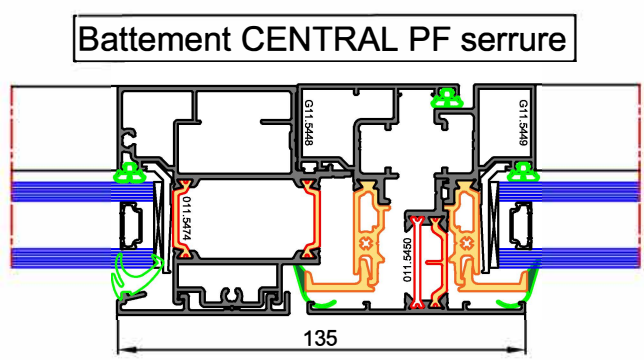

Battement CENTRAL PF serrure

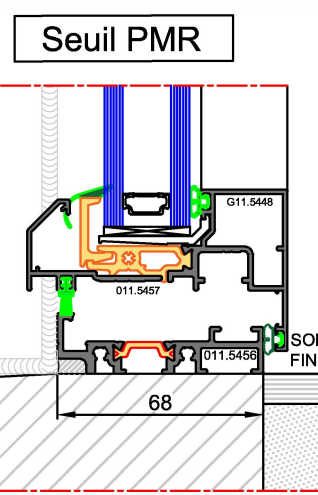

Seuil PMR

Sur appui et sous linteau = H

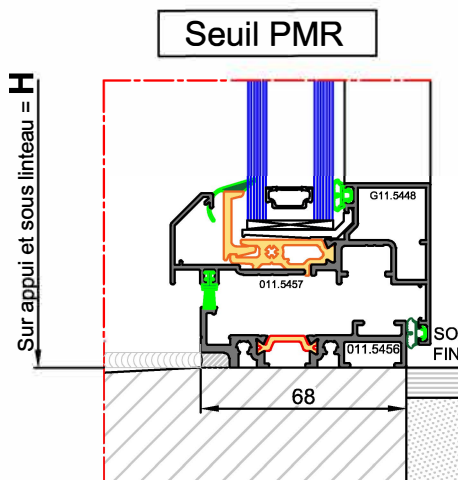
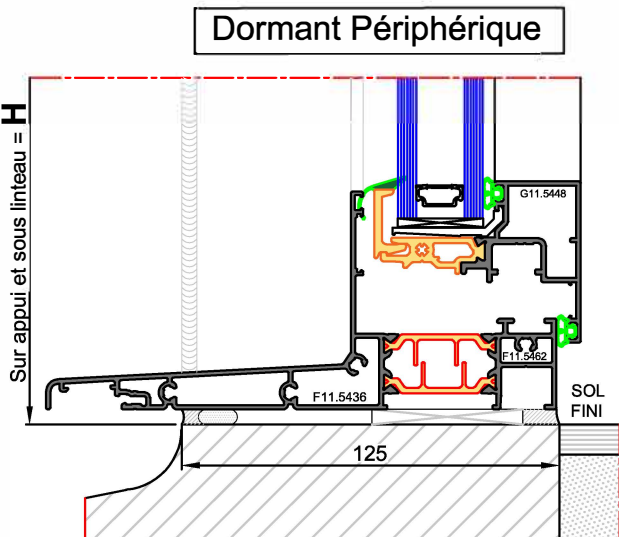
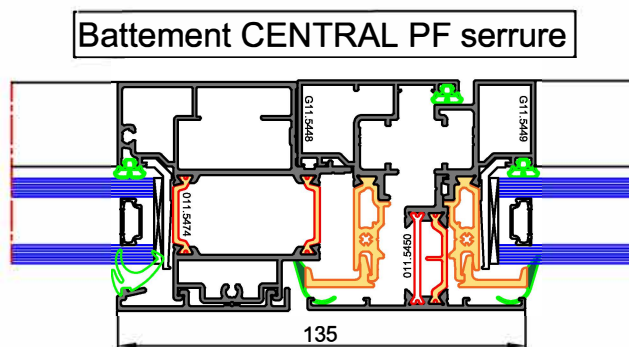
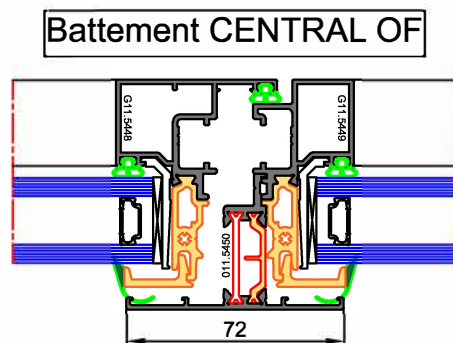
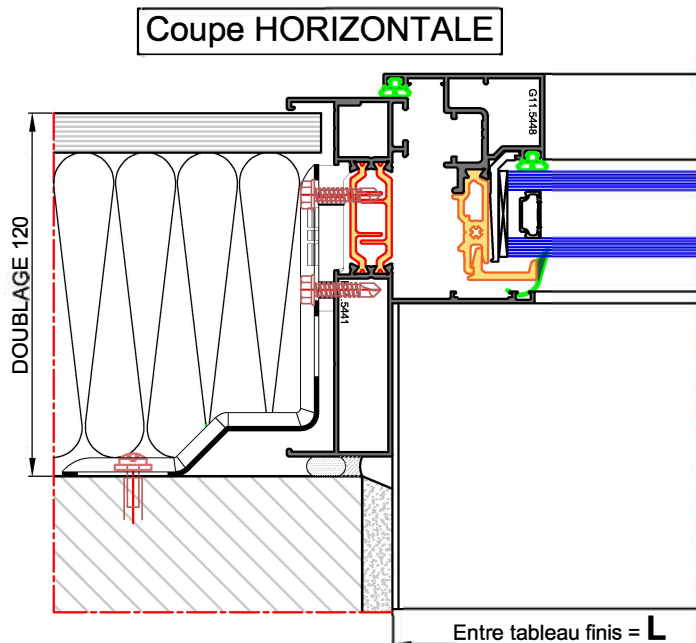
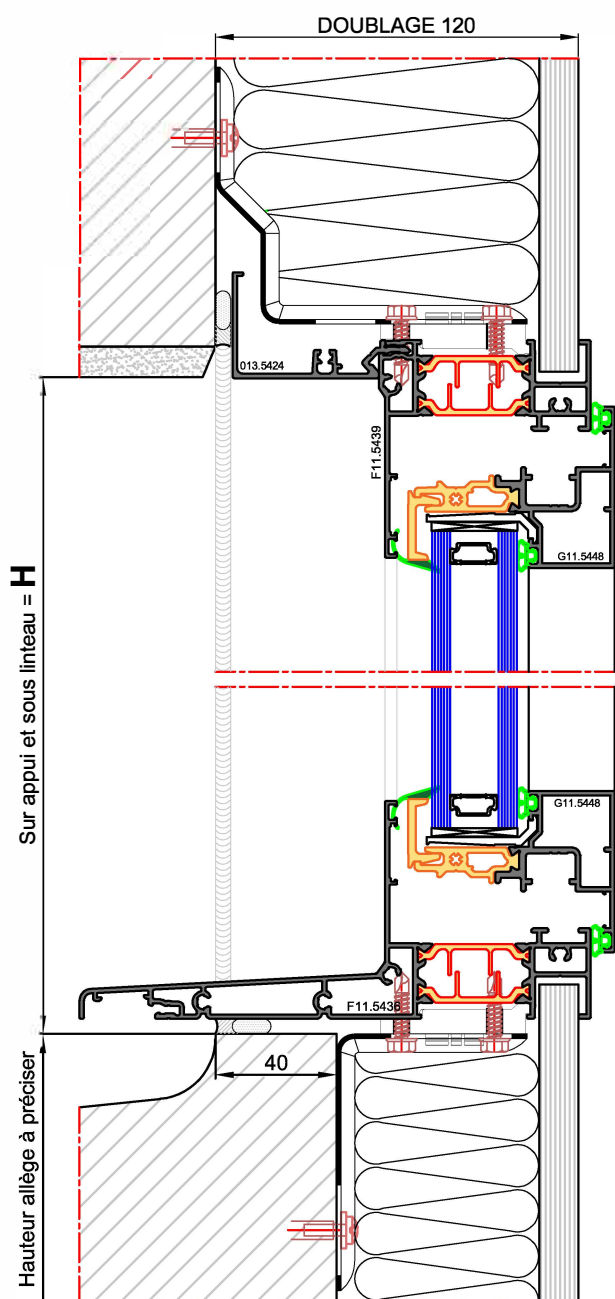

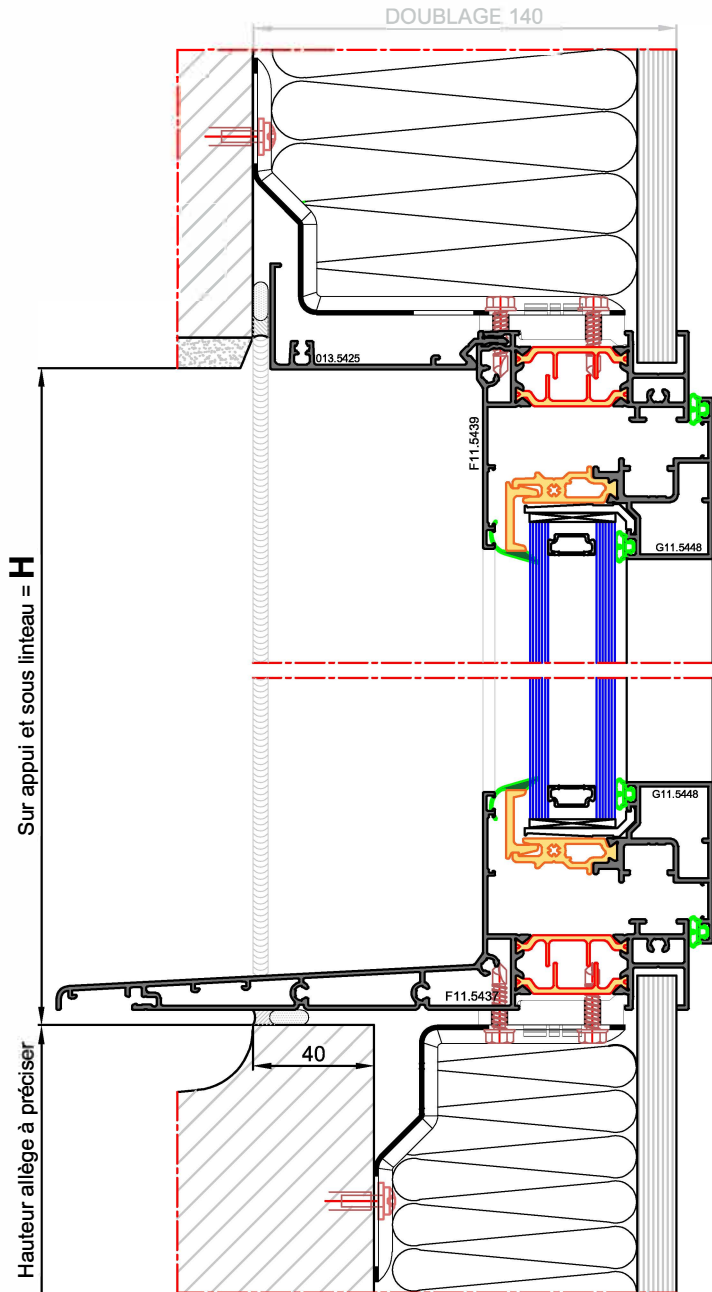

Coupe VERTICALE

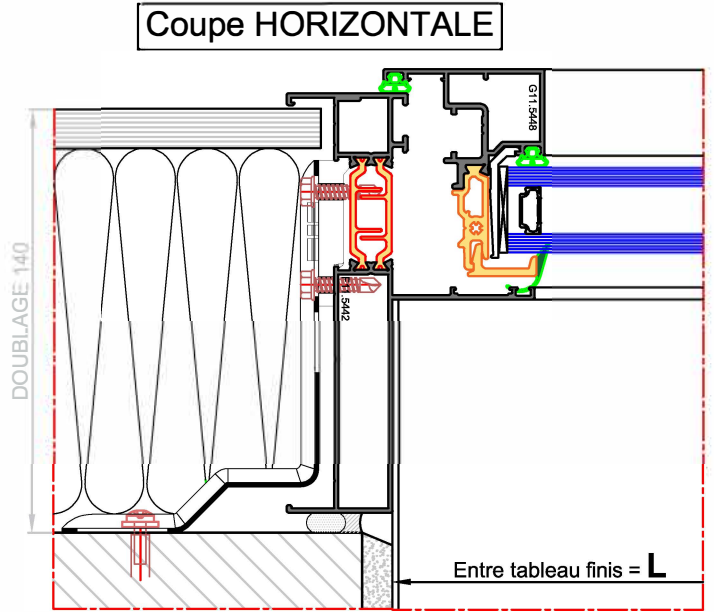

Battent CENTRAL OF

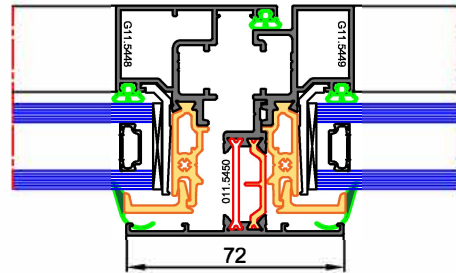

Battent CENTRAL PF serrure

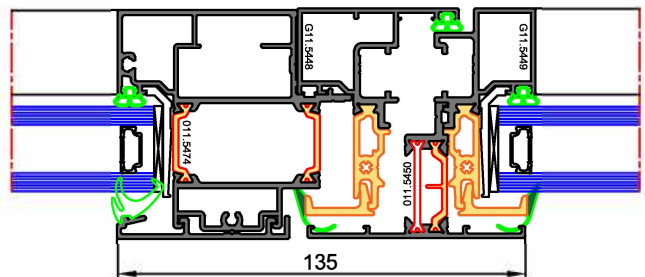

Dormant Périphérique

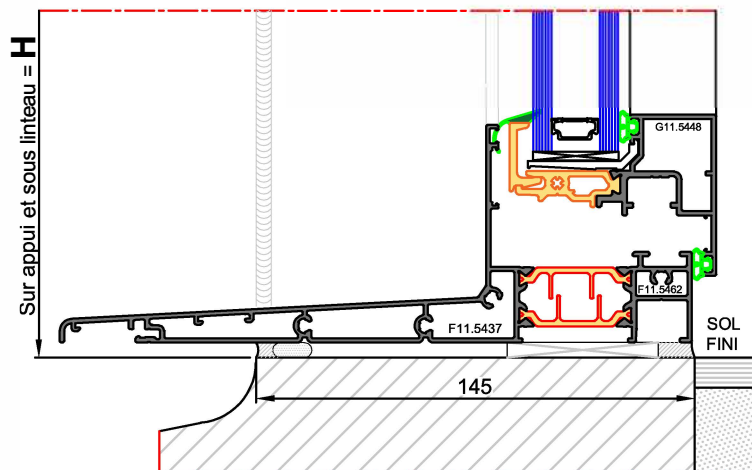

Seuil PMR

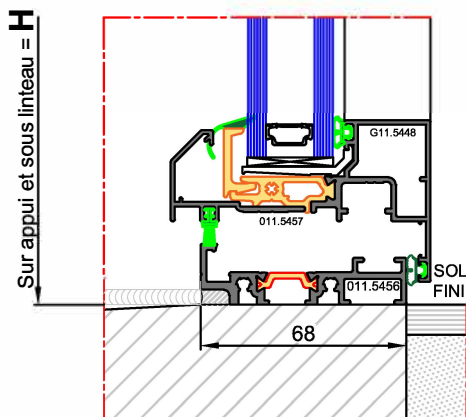

Coupe HORIZONTALE

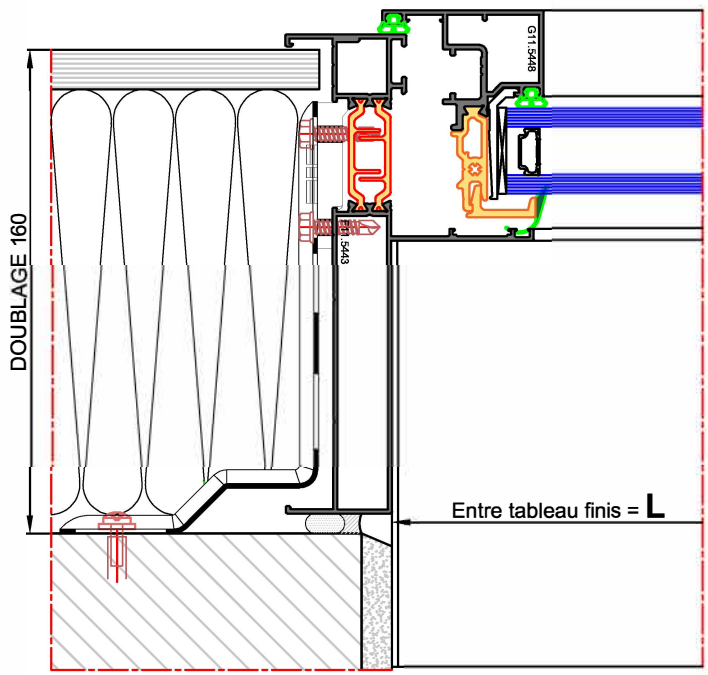

Sur appui et sous linteau = H

Hauteur allège à préciser

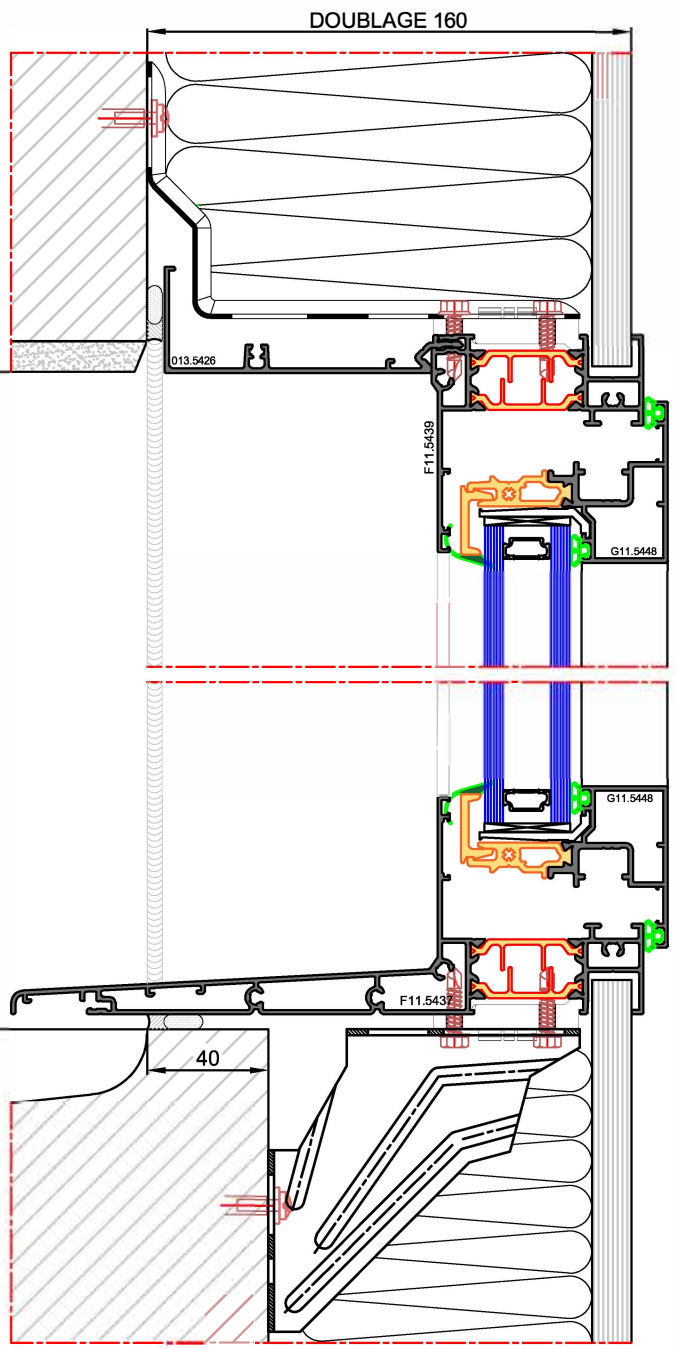

Coupe VERTICALE

Dormant Périphérique

Battent CENTRAL OF

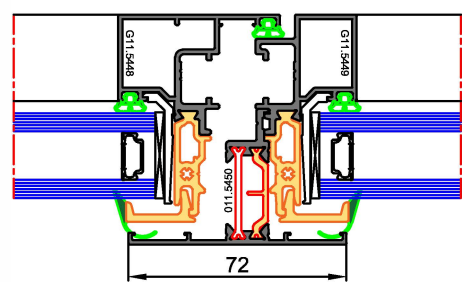

Battent CENTRAL PF serrure

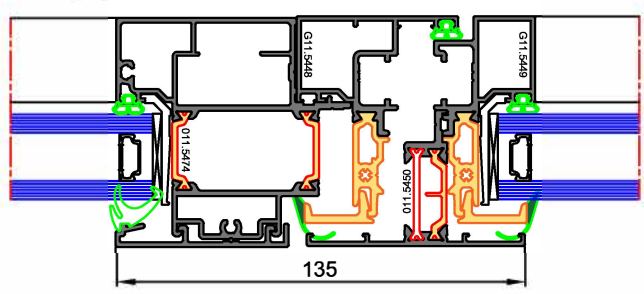

Seuil PMR

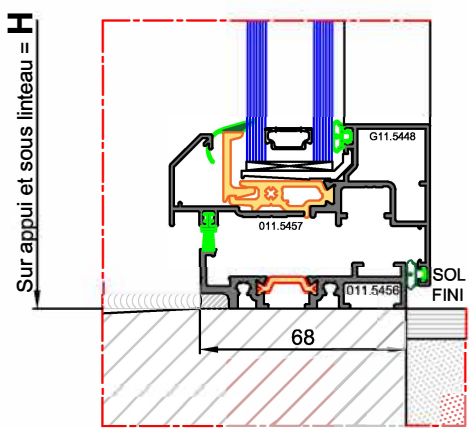

Sur appui et sous linteau = H

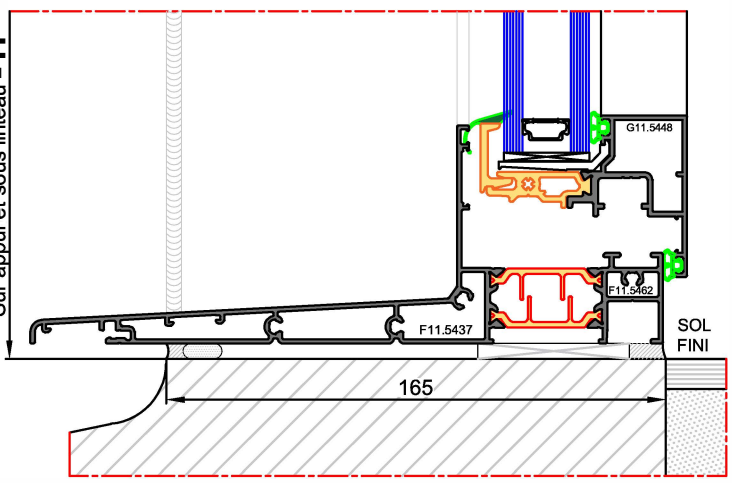



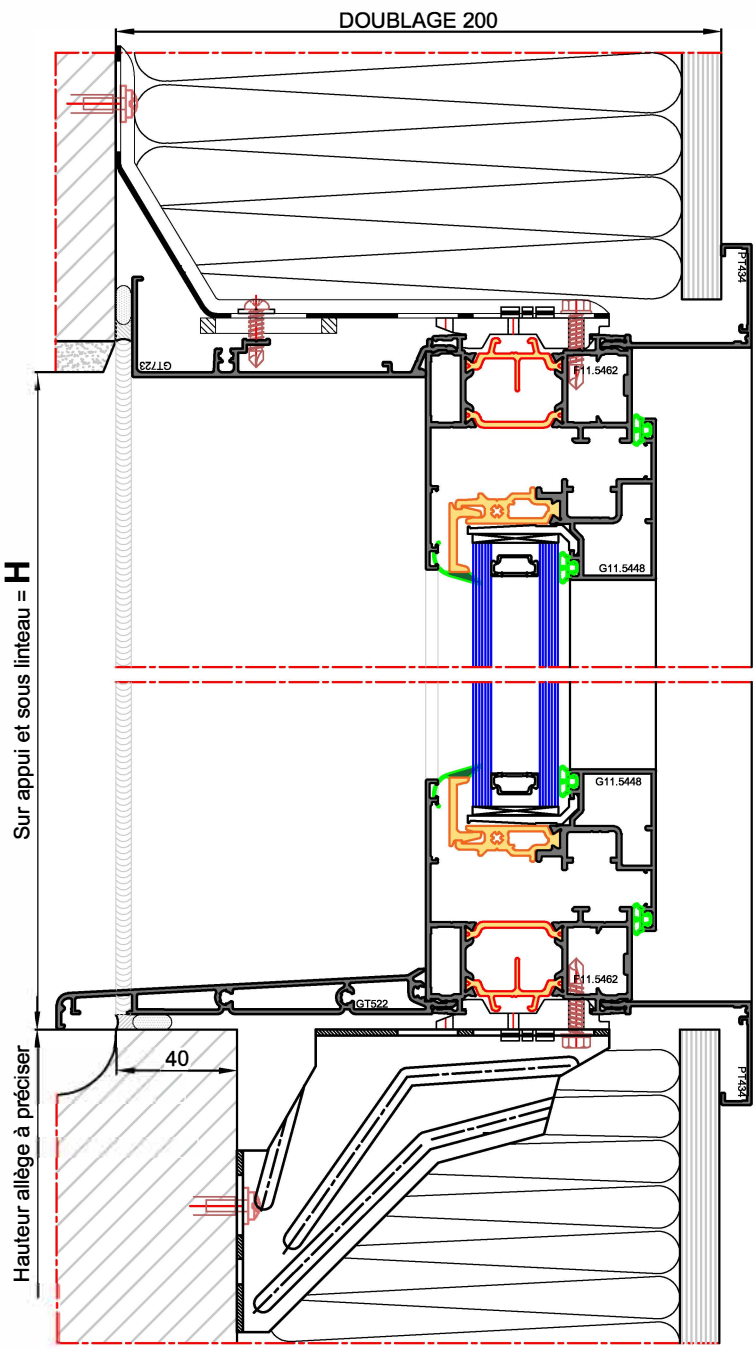

Coupe VERTICALE

Dormant Périphérique

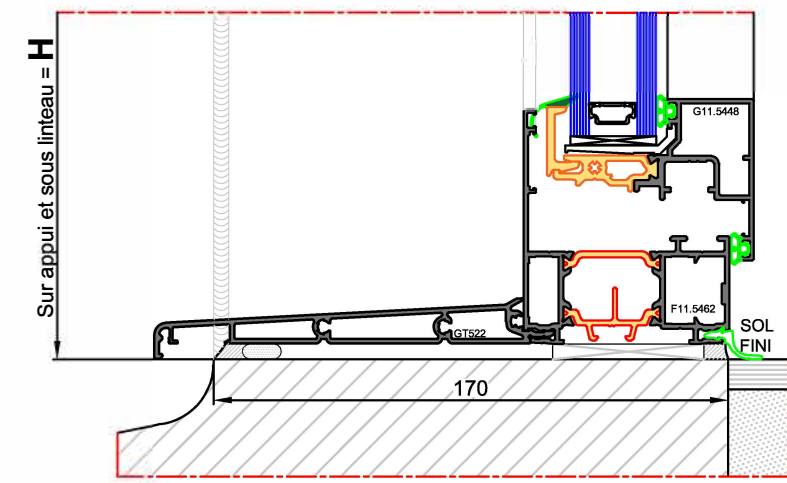

Coupe HORIZONTALE

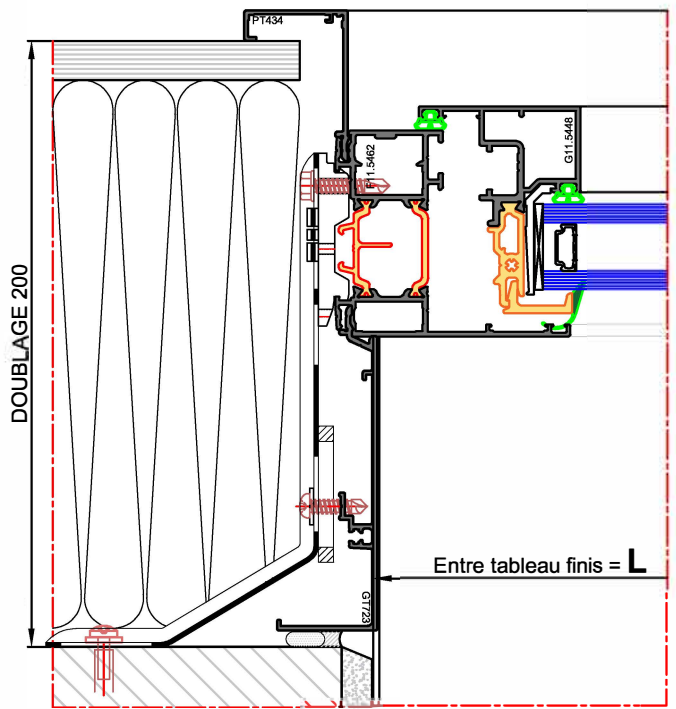

Battement CENTRAL OF

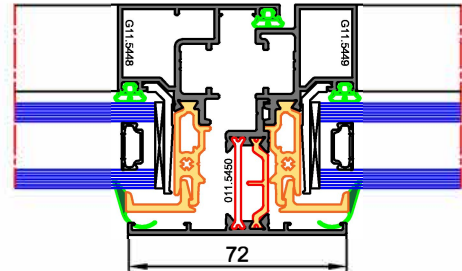

Battement CENTRAL PF serrure

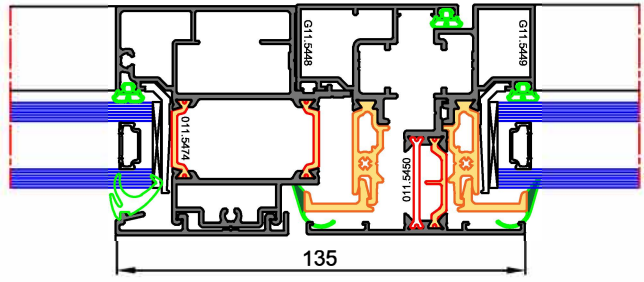

Seuil PMR

